



www.moon-sport.com

X-POWER 2500



P/N : 4897029981658

X-POWER 1800



P/N : 4897029982907

Designed in Hong Kong, Assembled in PRC

© copyright 2009-2017 Moon Sport Ltd. All rights reserved.



PROFESSIONAL LIGHTING SYSTEM

CONTENTS

CONTENTS INCLUDED & SPECIFICATION	1
HEAT SINK AND COOLING SYSTEM	2
EXPLOSION DIAGRAM	3 - 4
MOUNTING THE HEADLIGHT	5 - 6
LIGHT OPERATION	7 - 8
REMOTE SWITCH OPERATION	9 - 10
XP-BS-S4 / SS4 BATTERY OPERATION	11 - 12
XP-BS-S4 / SS4 BATTERY INDICATOR	13 - 14
BATTERY MOUNTING	15 - 16
RUN TIME & LIGHT DIAGRAM	17 - 18
TROUBLESHOOTING	19
WARRANTY & CARE	20

USER GUIDELINE

Thank you for choosing MOON X-power series headlight!

*For using this product safely, conveniently and keeping it well-preserved, please read this manual carefully before using. Please keep this manual for future reference.

*Due to the improvement of product, the product you have bought may not be exactly in accordance with the introduction of this manual. We apologize for this.



WEEE aims to ensure that products can be easily broken down for reuse, recycle or treatment at the end of the life cycle. A "Crossed Out Wheeled Bin" symbol and a unique identification of the product (such as a product registration number), and information such as reuse centres, treatment and recycling facilities are required on the product. Apart from product design, a robust system from logistic flow of the materials to production lines is also a matter of concern under WEEE.

CONTENTS INCLUDED

- * X-power 2500
- * Rechargeable lithium ion battery (6400mAh) pack
- * Handlebar bracket
- * Helmet mount
- * Remote switch
- * Extension cable
- * Smart charger
- * Magic tape band

SPECIFICATION

X-power 2500

- *4 Cree XM-L (U2) high brightness LEDs
- *CNC aluminum alloy body
- *7 modes : Over drive / High / Standard / Low / Flashing / Strobe / SOS
- *Quick release handlebar mount (fits 22-35mm)
- *Quick release helmet mount
- *Over heat protection system
- *Modes indicator
- *Low battery indicator
- *Precision optical lens

XP-BS-S4

- *Rechargeable lithium ion battery (7.2V 6400mAh)
- *Charging & fully charged indicator
- *Automatic turn on or off indicator (when plug in or pull out the DC & USB cable)
- *Taillight function with ON / OFF button
- *USB power output function

XP-NC

- *Smart charging (100-240 volts) with fully charged indicator and automatic fully charged cut-off system



RB-26

X-power 2500
X-power 1800



XP-BS-S4
(optional)



XP-BS-SS4
(optional)



RB-16

CONTENTS INCLUDED

- * X-power 1800
- * Rechargeable lithium ion battery (5200mAh) pack
- * Handlebar bracket
- * Helmet mount
- * Remote switch
- * Extension cable
- * Smart charger
- * Magic tape band

SPECIFICATION

X-power 1800

- *4 Cree XM-L (U2) high brightness LEDs
- *CNC aluminum alloy body
- *7 modes : Over drive / High / Standard / Low / Flashing / Strobe / SOS
- *Quick release handlebar mount (fits 22-35mm)
- *Quick release helmet mount
- *Over heat protection system
- *Modes indicator
- *Low battery indicator
- *Precision optical lens

XP-BS-SS4

- *Rechargeable lithium ion battery (7.4V 5200mAh)
- *Charging & fully charged indicator
- *Automatic turn on or off indicator (when plug in or pull out the DC & USB cable)
- *Taillight function with ON / OFF button
- *USB power output function

XP-NC

- *Smart charging (100-240 volts) with fully charged indicator and automatic fully charged cut-off system

HEAT SINK AND COOLING SYSTEM

The high brightness LED will heat up the light body while working, that is a high temperature light. A better cooling system can increase the running time, also increase 15%-30% brightness of the LED performance. To reduce the heat generated by the running LEDs, X-power 2500 & X-power 1800 are designed with aluminum alloy body and equipped with air venting cooling system (2 air-vent on both sides). The air venting cooling system lets air flows through the light body when riding. The light backside adopts novel shape design with high heat dissipation efficiency. It sufficiently disperse the heat away through the light.



FRONT VIEW

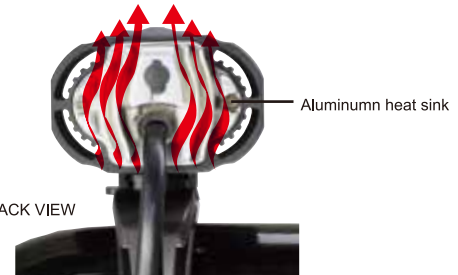

BACK VIEW



XP-1300-RM



XP-EW-0813



XP-BSM-0813



XP-NC

EXPLOSION DIAGRAM

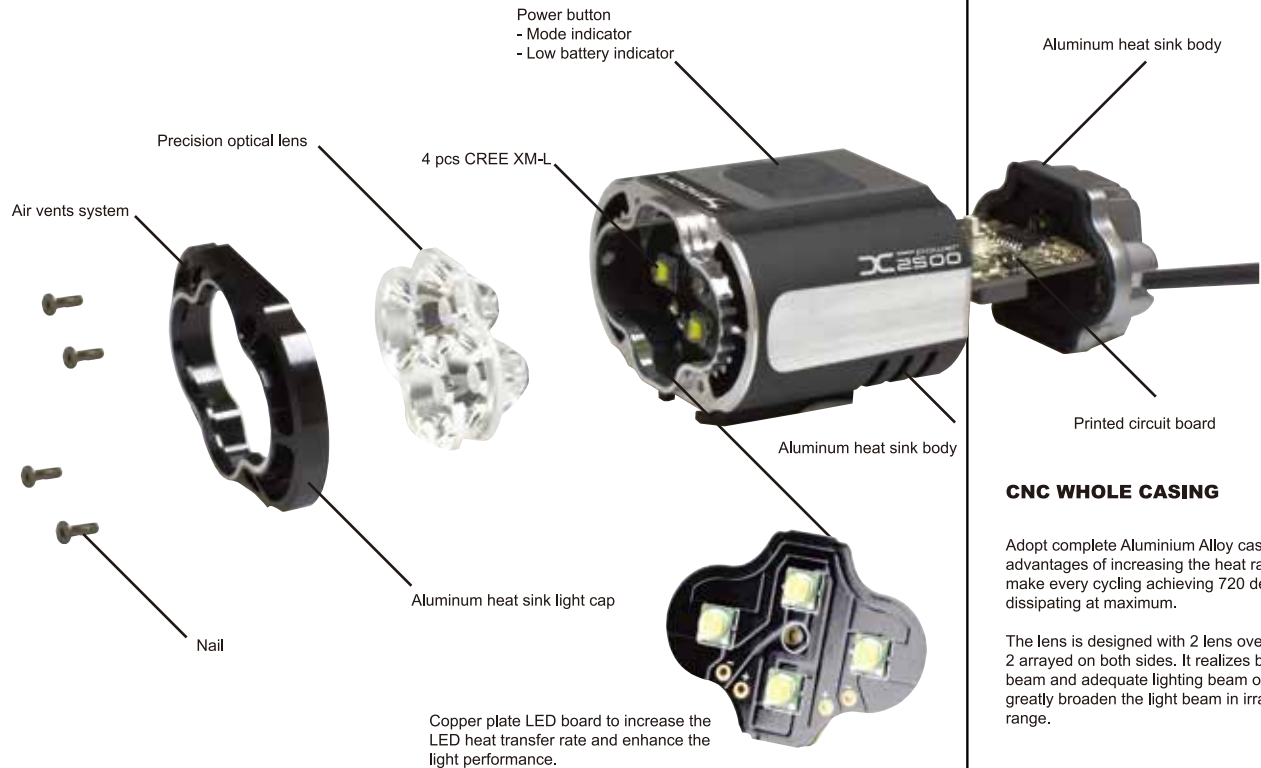

Light pattern

Distance 1M

Total angle 105°
Dia. 2.6M

Centra
12000 LUX

Side light
120 LUX

Spot angle 23°
Dia. 0.4M

Spot angle 34°
Dia. 0.6M

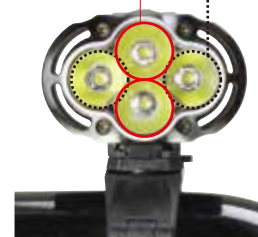

CNC WHOLE CASING

Adopt complete Aluminium Alloy case, it has the advantages of increasing the heat radiation area and make every cycling achieving 720 degree all-round heat dissipating at maximum.

The lens is designed with 2 lens overlapping and the other 2 arrayed on both sides. It realizes both fixing the central beam and adequate lighting beam on each side, and greatly broaden the light beam in irradiation direction and range.

HANDLE BAR MOUNTING

MOUNTING THE HEADLIGHT

1. Insert the handlebar bracket into the bottom slot of the light;
2. Spin the below part of the bracket counter-clockwise to loosen the screw;
3. Unlock the bracket and put the light in suitable place of your handle bar;
4. Twist the screw clockwise to lock the bracket.
5. The bracket fits 22-35mm handle bar. Additional shims are included and you can use them when necessary.

BEAM ADJUSTMENT

To adjust the horizontal beam, spin the headlight left to right for your best side to side beam angle. To adjust the vertical beam angle, loosen the mounting and rotate the light up and down to your best vertical beam angle, then tighten the mounting.



The beam is widely dispersed, besides its high brightness. To prevent from blinding the oncoming vehicles on the public roads, you'd better adjust the angle downward.



HELMET MOUNTING

MOUNT THE HEADLIGHT ONTO HELMET

1. Remove the belt from one side of the helmet mount.
2. Place the helmet mount into the suitable location on helmet.
3. Wrap belt around helmet and attach the end of the belt to itself tightly.
4. Insert the headlight into the helmet mount until it clicks into place.
5. Press down release lever to remove.

To adjust the vertical beam angle when mounted on the helmet, loosen the screw knob and rotate the light up or down to your desired angle, then tighten the screw knob to hold the light in place.

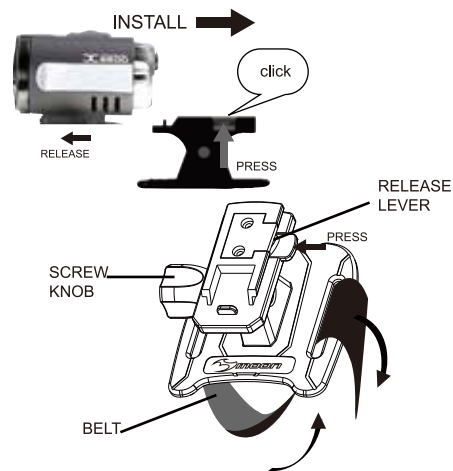

LIGHT OPERATION

LIGHT OPERATION

1. Press the power button to choose the modes:

In this button control, four modes are cycling in loop.

2. Fast press the on / off button two times to change to the flashing modes. Fast press two times back to the steady light cycle.

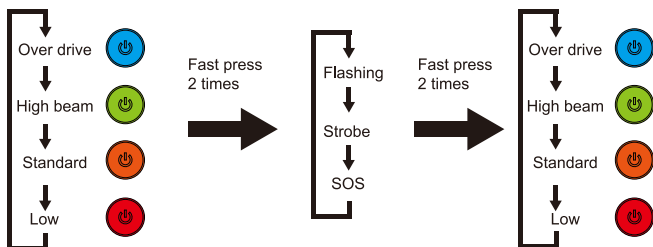

3. Press and hold the on / off button around 1 second to turn off the light.

4. When the indicator turns flashing red, it means the battery is low. You'd better charge the battery right now.

Low battery indicator

* Flashing red - Low battery



Never use the SOS sign unless there is a real emergency or dangerous occurring. The SOS signal is visible for several miles. And the battery can support for long runtime up to several hours.

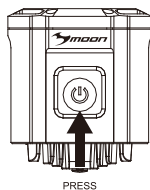

PRESS

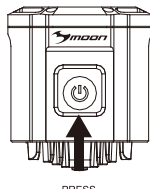

PRESS

Fast press 2 times
Change mode

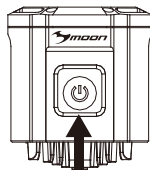

PRESS

Hold 1 sec.
Turn off



OVER HEAT PROTECTION

The over heat protection device can ensure the bicycle light in a good running temperature condition, so that to protect the LEDs without burning case.

When the bicycle light is running and without adequate air flow, this protection device will automatically start to dim the light to standard brightness mode, it can reduce the heat of the light and ensure the LEDs won't get damage due to over heat.

Once the air flow condition of the light is improved, the running temperature of the light will go down, then the over heat protection device will cut, the brightness of the bicycle light will get back to the beginning of the selected mode.

REMOTE SWITCH

REMOTE SWITCH OPERATION

Equipped with an outer setting controller, you could get handy with the light for brightness transferring into an approximate power when riding. And it will be helpful for heat dissipation and avoid any scalds occurrence when light working long and getting hot.

1. Open the light tail cover.
2. Then plug in the controller wire.
3. Make sure it has been completely jointed.



*When unused, please ensure the protective cap closed to avoid water getting in.

REMOTE SWITCH MOUNTING

1. Put one end of the belt go through the cycle handle bar
2. Align to the controller button and pass through.
3. Please pull the Velcro ends tightly.

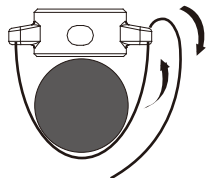

REMOTE SWITCH HELMET MOUNTING

1. Put one end of the belt go through the helmet hole.
2. Align to the controller button and pass through .
3. Please pull the Velcro ends tightly.



REMOTE SWITCH OPERATION

1. Press the power button to choose the modes:

In this button control four modes are cycling in loop.

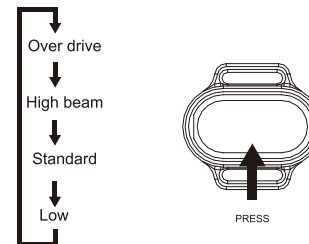

2. Fast press the on / off button two times to change to the flashing modes. Fast press two times back to the steady light cycle.

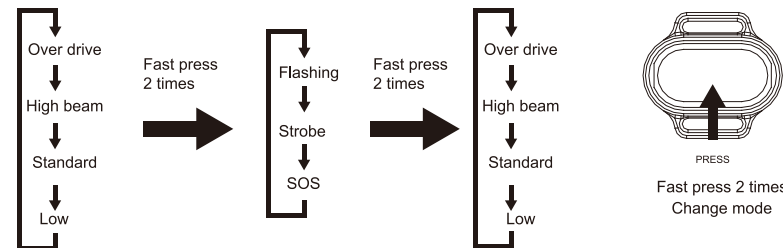

3. Press and hold the on / off button around 1 second to turn off the light.



Never use the SOS sign unless there is a real emergency or danger occurring. The SOS signal is visible for several miles. And the battery can support for long runtime up to several hours.

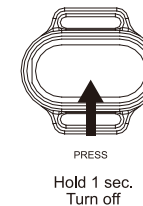

XP-BS-S4 / SS4 BATTERY OPERATION



XP-BS-S4 / XP-BS-SS4

It is normal that the battery may get high temperatures during charging (up to 104°F/40°C), as the chemical in battery is in reaction. If the battery is not drained completely before charging, it may also get warm.

Several factors can influence the battery's durability: type of cell strain, the maintenance routine, the temperature and etc. Normally, the higher the battery capacity, the longer the running time.

The battery capacity may become less effectiveness; about 80% of its value after 300-500 charge/discharge cycles. The battery may have 3 years life span under good care.

The battery voltage and capacity decrease apparently at low temperatures, especially near or below ice point. The capacity decreases 5%-10% at freezing. At -20°C, the capacity decreases 30%. The battery performance will return normal when the temperature gets up to 70°F/20°C.





The battery will lose around 1% of its capacity per day when you store the battery at normal room temperature. Battery temperature should never exceed 104°F/40°C, it will lose about 5% of its capacity per day.

If you don't use the battery for a long time, be sure to make it a fully recharge every 3 months before storing again. Please keep the battery in cool and dry place when storing.



BATTERY CONNECTION

1. Plug in the DC cable
2. Plug in the USB cable (Do not use in raining)
3. Both plug in

XP-BS-SS4

INPUT : 8.4VDC  1.5A
 RATING : 7.4V  5200mAh
 38.48 Whr
 RATING : 3.7V  10400mAh
 OUTPUT : 5.0VDC  1.5A

XP-BS-S4

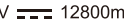
INPUT : 8.4VDC  1.5A
 RATING : 7.2V  6400mAh
 46.08 Whr
 RATING : 3.6V  12800mAh
 OUTPUT : 5.0VDC  1.5A



Method 1



Method 2



Method 3

BATTERY OPERATION

1. Press the power button will show the battery capacity.
2. Press the power button two times to change into the taillight modes.
3. Press the power button two times again to get back to the capacity mode.
4. Press and hold the power button around 1 sec. in any modes to turn off.

*Make sure the cover is closed in place. When not use.

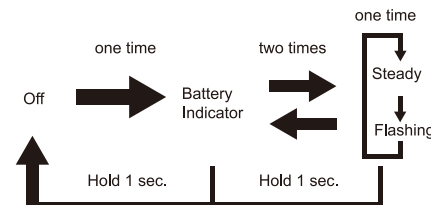

POWER BUTTON

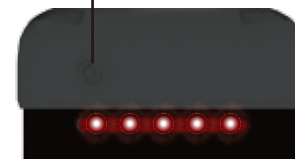

XP-BS-S4 / SS4 BATTERY INDICATOR

INDICATOR

100% = 5 LED
80% = 4 LED
60% = 3 LED
40% = 2 LED
20% = 1 LED



100% = 5 LED



80% = 4 LED



60% = 3 LED



40% = 2 LED



20% = 1 LED

TAILLIGHT FUNCTION

XP-BS-S4

There are two modes in tail light function.

1. Steady – 6 LUMENS ,70 hours runtime(in full capacity)
2. Flashing– 100 hours runtime

XP-BS-SS4

There are two modes in tail light function.

1. Steady – 6 LUMENS ,55 hours runtime(in full capacity)
2. Flashing– 78 hours runtime

EXTENSION DC CABLE

If the distance between the headlamp and the battery is very far away, you can use the extension DC cable provided.

Insert one end of the extension cable to the headlamp cable port and insert the other end to the battery cable port until you hear a click sound.

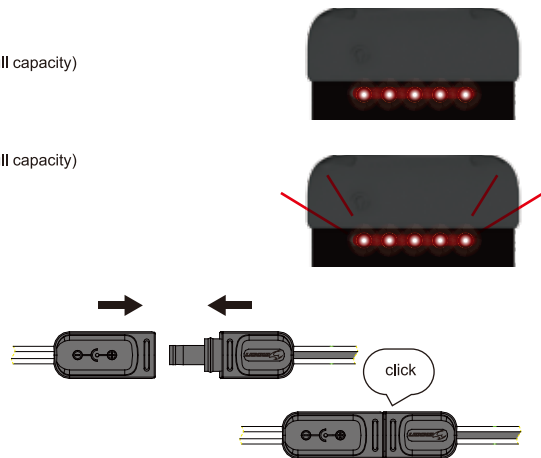

BATTERY CHARGING

Attention: MOON would like to recommend you to use the original supplied charger to charge the battery. The battery will be harmed if you use any other chargers. Unplug the charger once the battery is fully charged. Never use the smart charger at outdoor.

BATTERY CHARGING – CONTINUED

- 1.Connect the battery and the charger.
- 2.Connect the charger to the wall outlet.
- 3.The charger shows steady red when charging.
- 4.After fully charged it changes to steady green.
- 5.Smart charging ensures longer battery life.
- 6.Wall charger is compatible with 100 to 240 volts, for worldwide use.

Charging indicator

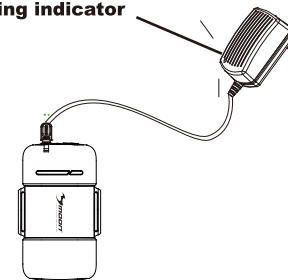

CHARGING INDICATOR

100% = 5 LED
80% = 4 LED
60% = 3 LED
40% = 2 LED
20% = 1 LED



20% = 1 LED



40% = 2 LED



60% = 3 LED



80% = 4 LED



100% = 5 LED

BATTERY MOUNTING

SEAT POST / BAR MOUNTING THE BATTERY

Method 1

1. Thread the Velcro strap counter-clockwise through the 2 slots at the side of the battery. The hook surface of the Velcro strap should face the battery.
2. Place the battery on the frame where is safe and convenient.
3. Wrap the Velcro strap over the tube
4. Thread the Velcro strap through the slot on the top end of the strap itself.
5. Pull the Velcro strap and attach it tightly and firmly.

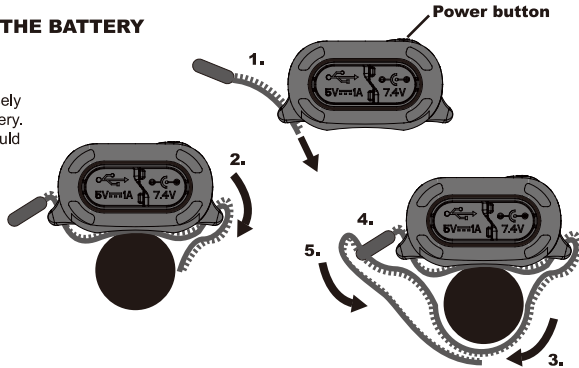

Method 2

1. Thread the Velcro strap clockwise through the 2 slots at the side of the battery. The hook surface of the Velcro strap should back the battery.
2. Place the battery on the frame where is safe and convenient.
3. Wrap the Velcro strap over the tube
4. Thread the Velcro strap through the slot on the top end of the strap itself.
5. Pull the Velcro strap and attach it tightly and firmly.

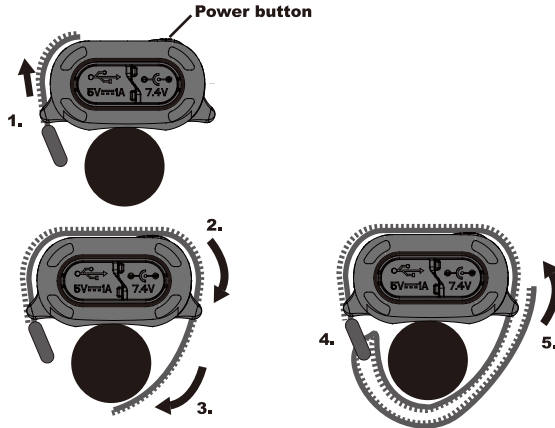

MOUNTING



SEAT POST
MOUNT

RUN TIME & LIGHT DIAGRAM

LIGHT DIAGRAM

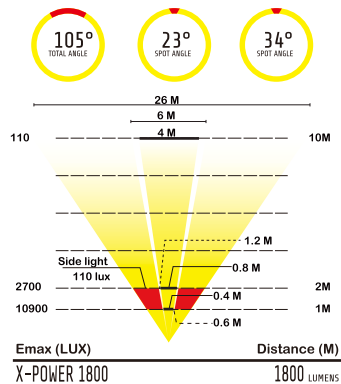
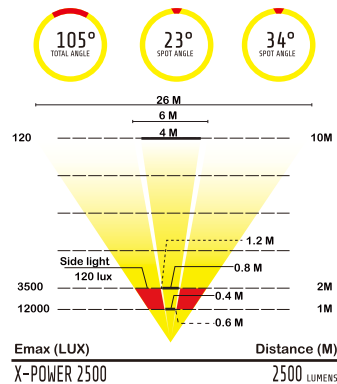

X-POWER 1800 (XP-BS-S4)6400mAh (optional)

mode	Lumen	runtime	weight	charge time
Over drive	1800	Up to 2 hours 15 mins		
High	1200	Up to 3 hours 20 mins	Light body 136 g	
Standard	850	Up to 5 hours 10 mins	Battery case 290 g	6 hours
Low	400	Up to 11 hours 15 mins		
Flashing	1200	Up to 9 hours 30 mins		
Strobe	1200	Up to 9 hours 20 mins		

X-POWER 1800 (XP-BS-SS4)5200mAh

mode	Lumen	runtime	weight	charge time
Over drive	1800	Up to 1 hour 40 mins		
High	1200	Up to 2 hours 30 mins	Light body 136 g	
Standard	850	Up to 3 hours 40 mins	Battery case 290 g	5 hours
Low	400	Up to 8 hours		
Flashing	1200	Up to 6 hours 30 mins		
Strobe	1200	Up to 6 hours 20 mins		

X-POWER 2500 (XP-BS-S4)6400mAh

mode	Lumen	runtime	weight	charge time
Over drive	2500	Up to 1 hour 40 mins		
High	1500	Up to 2 hours 30 mins	Light body 136 g	
Standard	1100	Up to 3 hours 40 mins	Battery case 290 g	6 hours
Low	500	Up to 9 hours 40 mins		
Flashing	1600	Up to 7 hours 30 mins		
Strobe	1600	Up to 6 hours 20 mins		

TROUBLESHOOTING

HEADLIGHT

The headlight cannot be turned on.

- *Make sure the power button was firmly pressed.
- *Make sure battery is securely connected with the headlight.
- *Make sure the battery is fully charged.

The headlight turns off over rough terrain.

- *Make sure battery is securely connected with the headlight.

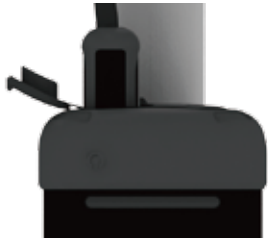

REMOTE SWITCH

The headlight cannot be turned on with remote switch.

- *Make sure the power button was firmly pressed.
- *Make sure battery is securely connected with the headlight.
- *Make sure the battery is fully charged.

The headlight turns off over rough terrain.

- *Make sure battery is securely connected with the headlight.
- *Make sure the control button is securely connected with the headlight.

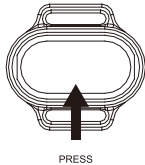

BATTERY

The battery cannot be turned on.

- *Make sure the power button was firmly pressed.
- *Make sure the battery is fully charged.

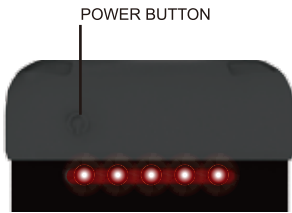

EXTENSION CABLE

The headlight cannot be turned on with extension cable.

- *Make sure the cable is connected in place.
- *Make sure the cable is securely connected with the headlight.
- *Make sure the cable is securely connected with the battery.

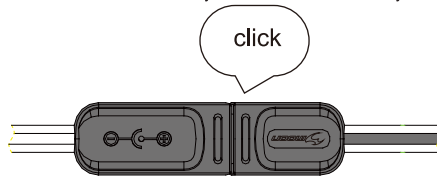

CARE

CAUTION

The X-power 2500 , X-power 1800 are designed to be used on bikes in some of the most extreme outdoor conditions. Over time, dust and dirt may hinder the connections on your battery and headlight. To prevent this happen, ensure both of battery and headlight are cleaned after every ride.

Wipe the headlight and battery down with a damp cloth. Do not submerge the battery or headlight in water. Remove all dirt around or on the plugs or jacks on both the battery and headlight. The CREE XM-L high-brightness LEDs have extensive life so bulb replacement is not required.



CAUTION: Night riding is more dangerous than day riding.

Exercise caution when riding at night and follow the guidelines listed below:

- *Headlines may get hot during use. Caution to use when handling.
- *Unplug the battery, headlight and remote switch when not in use.
- *Unplug the battery and charger when fully charged.
- *Unplug connector by the plug, never by the cable.
- *Only use the provided charger when charging.
- *Do not modify or substitute any parts with Non-MOON parts.
- *Do not disassemble the headlight and battery case.
- *Provide adequate airflow to the headlight to cool during use.
- *Do not look directly at light.
- *Do not operate or submerge any parts of the system under water.
- *Do not operate the light unattended.
- *Keep headlight and battery away from fire and combustible materials.
- *Do not store head unit when it is hot or immediately after use.
- *Carrying a flash light is recommended.
- *Do not dismantle the battery case.
- *Keep battery away from fire and combustible materials.
- *Do not charge except specified charging condition.
- *Do not heat above 100°C or short circuit.
- *This light is for bicycle use only.

WARRANTY

WARRANTY

MOON warrants to the original purchaser of this product that the product is free from defects in material and workmanship for a period of one year. This warranty does not apply to damage due to heat, physical damage resulting from abuse, neglect, improper repair, improper fit, or alterations of the fixture. This warranty is in lieu of all other agreements and warranties, general or specific, express or implied and no representative or person is authorized to assume liability on behalf of MOON in connection with the sale and use of this product.

MOON reserves the right to request the return of any product submitted for warranty consideration. All customers should contact the local dealer or regional distributor for warranty service.

To make a claim, first call local dealer or regional distributor. Some issues may be resolved upon the initial call. If return of the product is necessary, please refer to the following instructions:

- *We recommend that items be sent by a traceable method (such as FedEx or UPS). MOON is not responsible for lost or misdirected packages.
- *Please include your full contact information (name, address, phone number, and email [if applicable]), and a description of the issue.
- *Address items to: local dealer or regional distributor

What is not covered: MOON Lights are covered by a ONE YEAR LIMITED WARRANTY from the date of purchase. This covers the lights and cables only. It does not cover the battery or battery internals.

Batteries are covered by 120 days warranty.

For more information please contact us at cs@moon-sport.com.